

MYTHO TECHNOLOGIES

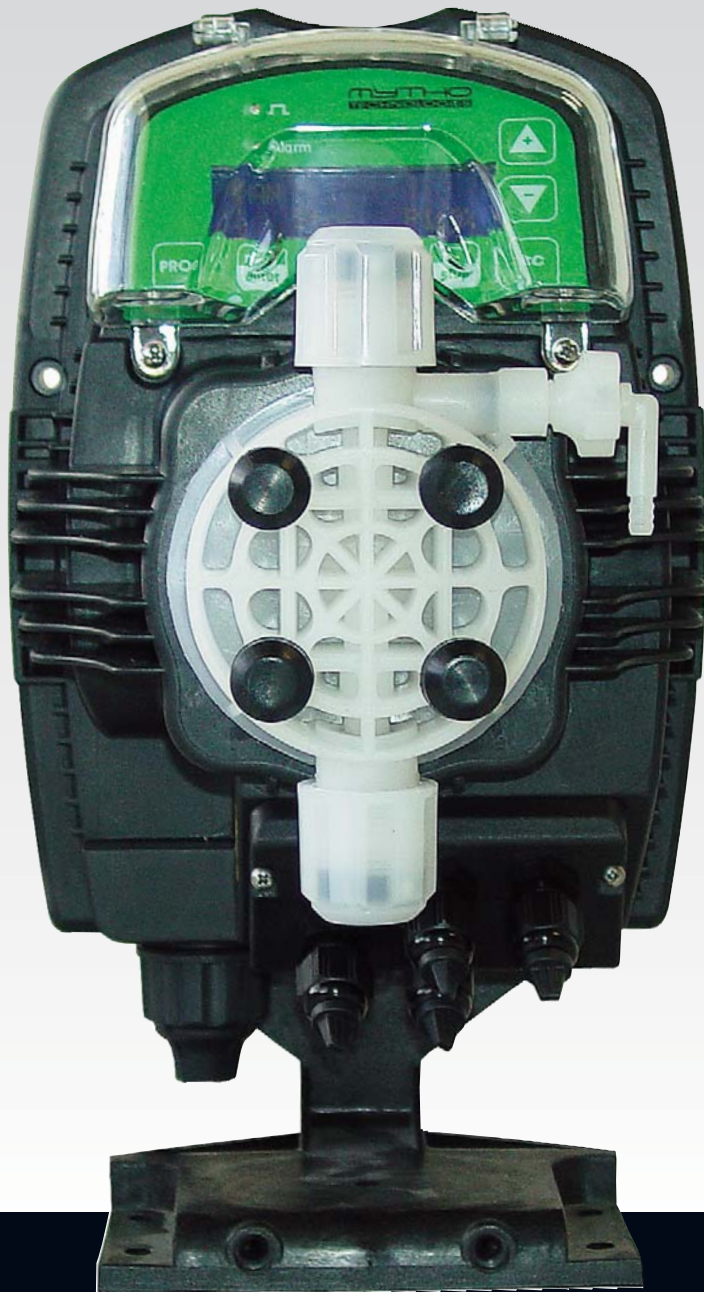

H Series
solenoid dosing
pumps

Solenoid dosing pumps



Analogue Version



Digital Version

Clever

Just 5 Models, Just PVDF, All functions in one pump

- ▶ 4 models that cover 1 to 60 l/h with an output pressure up to 20 Bar
- ▶ 1 Casing allows skids to be pre-constructed, as the fixing points remain constant, and the pumps can be selected on confirmation of the dosing flow
- ▶ Inventory Reduction
- ▶ Reduce spares stock holding

Compatible

PVDF pump head and ceramic ball valve as standard

- ▶ PVDF is suitable for almost all chemical used in the Industrial, Waste Water Treatment and potable Water applications
- ▶ The use of Ceramic balls as standard improves the pumping reliability and the chemical compatibility of the whole liquid end
- ▶ Full chemical compatibility

Reliable

Long life diaphragm tested to give 5 years working life

- ▶ The advanced design and manufacturing process allows the diaphragm to have a unique life expectancy
- ▶ Made of pure solid PTFE, the diaphragm is compatible with most chemicals
- ▶ The diaphragm has been tested over a period of 5 years giving superior results
- ▶ Routine diaphragm replacement is no longer a requirement
- ▶ Reduced maintenance
- ▶ Full chemical compatibility

Steady Dosing Performance

Stabilized Multi Power Supply 100÷240 Vac 50/60 Hz with reduced consumption

- ▶ Reduced power consumption as the solenoid only draws the required power to activate the pump, based on the working conditions
- ▶ Stable dosing performance: improve pump efficiency as performance is not affected by power supply fluctuations
- ▶ Reduce inventory holding

Intuitive programming

A new concept of programming menu

- ▶ Programming menu are self explanatory and available in 5 languages
- ▶ Intelligent Display, once a function is selected the pump will only display the parameters to set, which are linked to the selected function
- ▶ Reduced programming time

Code

HL	30	N	H	H	0	000
						Options
						Code
						000
						Description
						Standard
						Seals
						Code
						0
						Materials
						FPM
						1
						EPDM
						Installation Kit
						Code
						P
						Materials
						PVC
						H
						PVDF
						Pump head material
						Code
						H
						Pump head
						PVDF
						Connections
						Balls
						Ceramic
						Diaphragm
						PTFE
						Power supply
						Code
						N
						100 ÷ 240 Vac
						O
						24 ÷ 48 Vac (just for HS and HLersion)
						50-60 Hz
						Model
Code	Pressure [bar]	Flow rate [l/h]	Frequency max [stroke./min]	Stroke capacity [cc/stroke]	Ø Connections IN / OUT [mm]	Consumption [W]
10	20	0.4	120	0,06	4 / 7	12,2
	16	0.8		0,11		
	10	1.2		0,16		
	6	1.5		0,21		
20	20	2.5	120	0,35	4 / 6 suc. 4 / 7 dis.	12,0
	18	3		0,42		
30	12	4	160	0,42	4 / 6	12,2
	10	5		0,52		
	8	6		0,63		
	2	8		0,83		
40	12	7	300	0,39	4 / 6	23,9
	10	10		0,55		
	5	15		0,83		
	1	18		1		
50	5	20	300	1,11	8 / 12	22,2
	4	25		1,39		
	2	38		2,11		
	0,1	54		3		
						Version
Code	Interface	Description				
HS	Analogue	Analogue dosing pump with constant flow rate manually adjustable				
HL		Analogue dosing pump with constant flow rate manually adjustable				
HP		Analogue dosing pump with constant flow rate manually adjustable, with proportional flow rate according to an external analog (4÷20 mA) or digital signal (water meter)				
HG	Digital	Digital dosing pump with constant flow rate manually adjustable, with proportional flow rate according to an external analog (4÷20 mA) or digital signal (water meter)				
HR		Digital dosing pump with pH/Redox control meter on board				
HK		Digital dosing pump with constant flow rate or timed				

Technical Features

- ▶ Casing made of PP reinforced with glass fibre
- ▶ IP 65 rated
- ▶ PTFE diaphragm
- ▶ Level control input
- ▶ Priming valve
- ▶ Complete standard installation kit composed by: foot filter and injection valve, PVC suction tube, PE delivery tube and fixing bracket

Pressure [bar]

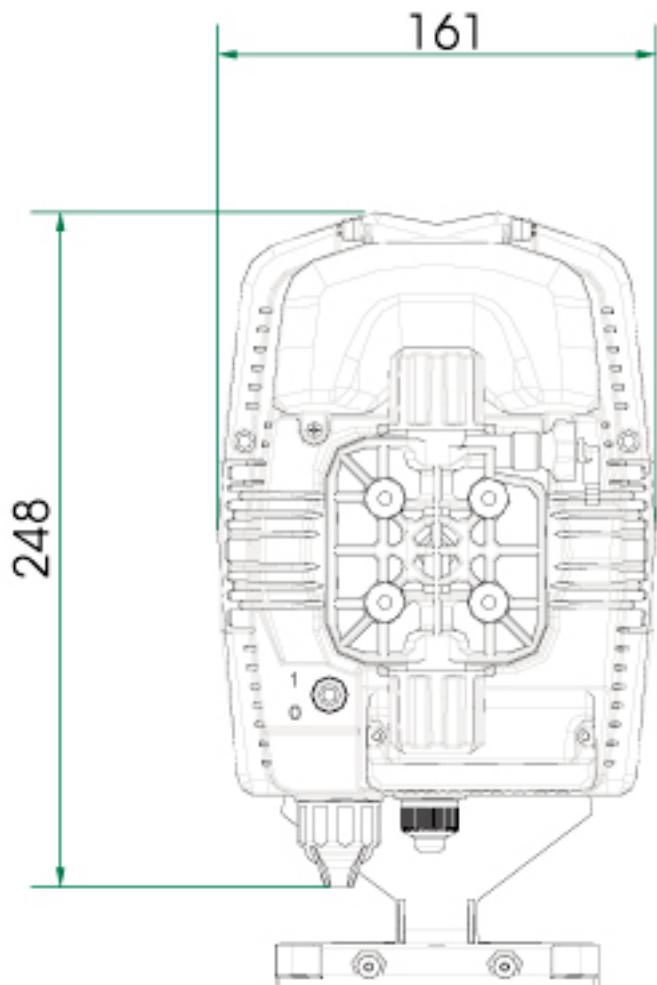
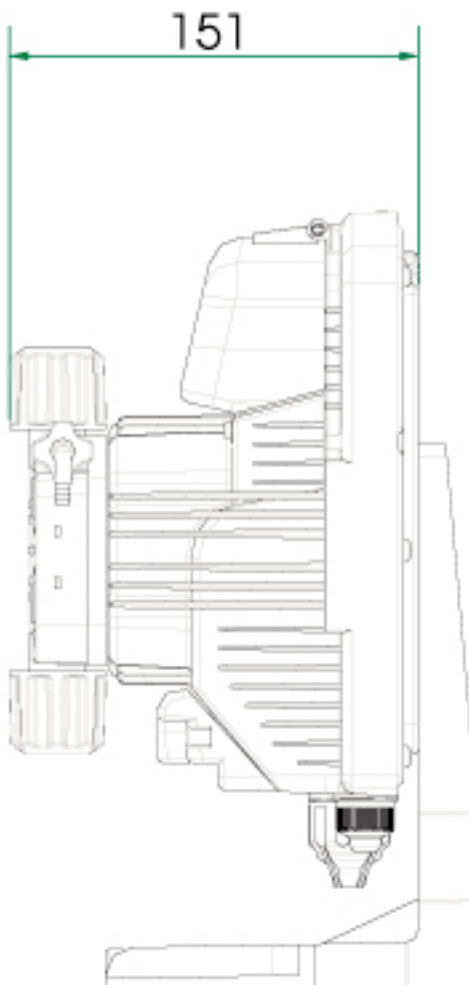
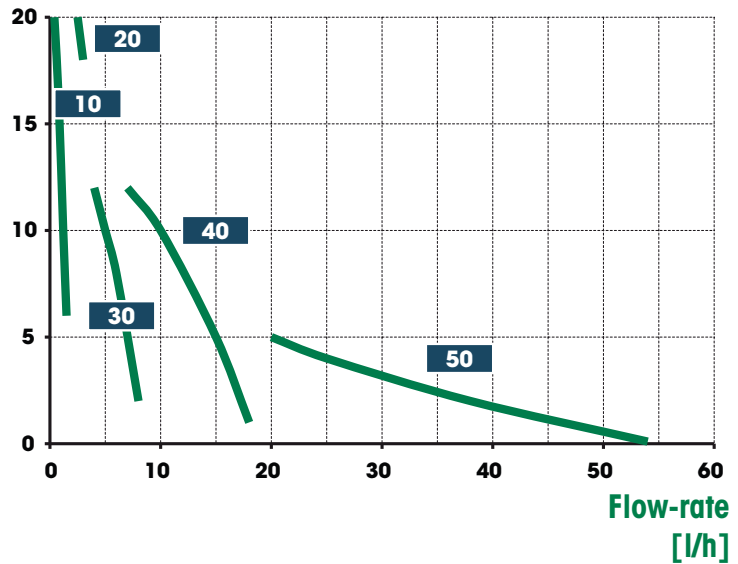

Analogue Version

HS constant dosage

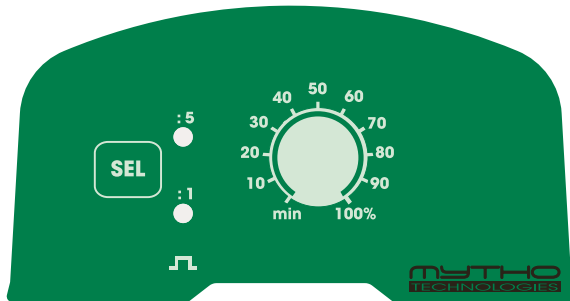

Analogue dosing pump with constant flow rate manually adjustable by control dial on the front panel, two frequency range (0÷20% or 0÷100%), Power-ON led indicator

Without level control input and fixing bracket

HL constant dosage

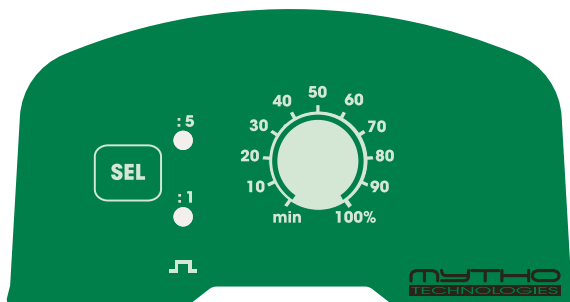

Analogue dosing pump with constant flow rate manually adjustable by control dial on the front panel, two frequency range (0÷20% or 0÷100%), Power-ON led indicator

HP proportional dosage

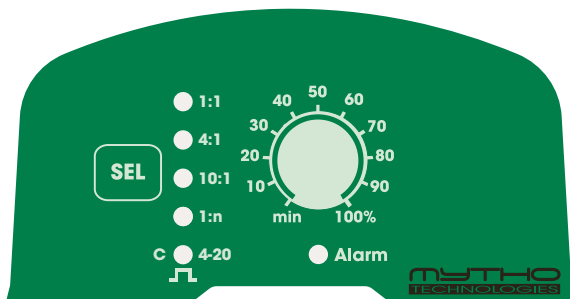

Analogue dosing pump with constant flow rate manually adjustable, proportional flow rate according to an external analogue (4÷20 mA) or digital pulse signal (e.g. from water meter).

- ▶ Control dial (percentage and "n" value in multiplication mode)
- ▶ 6 position adjustable switch:
 - 3 in division mode (1, 4, 10 = n)
 - 1 in multiplication mode (n=1)
 - 1 for proportional 4÷20 mA signal
 - 1 for constant functionality
- ▶ "pacing" function adjustable by dip switch

Digital Version

HG proportional dosage

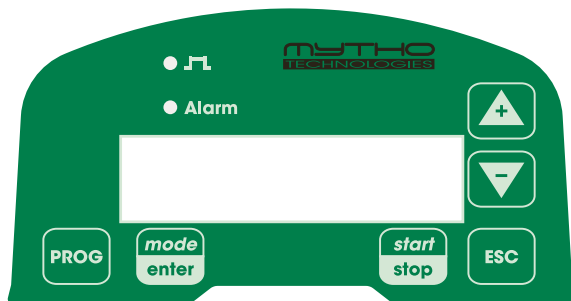

Pompa elettromagnetica a dosaggio costante con regolazione manuale, proporzionale a segnale digitale (contatore) o segnale analogico (4÷20 mA).

E' la versione ad interfaccia digitale della HP con in aggiunta: funzione timer, dosaggio in ppm, statistiche, password e ingresso On-Off (interruttore remoto)

HR proportional dosage

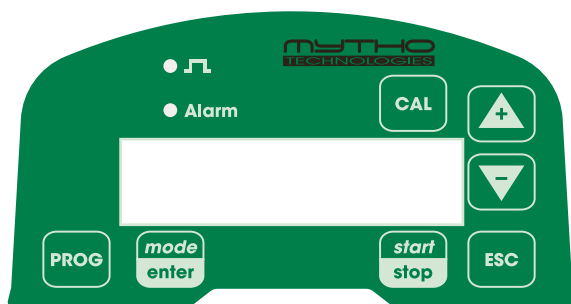

Digital dosing pump with pH/Redox control meter built in.

- ▶ Digital interface for constant or proportional dosing, depending on the measured pH or Rx value
- ▶ PT100 probe input for thermal compensation
- ▶ Repetition alarm relay
- ▶ Input On-Off for remote control
- ▶ 4÷20 mA output for measure transmission

HK timed dosage

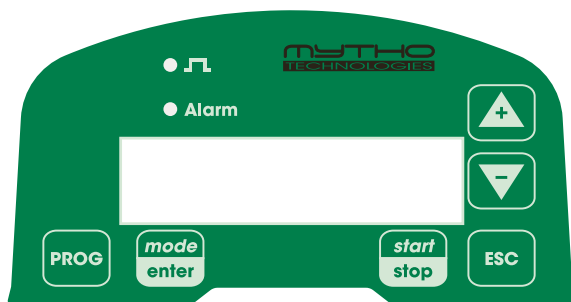

Digital dosing pump with constant flow rate manually adjustable, or timer control.

- ▶ Programmable timed relay

Accessories

Threaded water meters

The meters which we offer have high precision and sensitivity according to CEE standards. Their plastic and metallic parts, in particular those in contact with water, comply with current regulations and are subject to extensive checks and controls.

CB Series	CB4 4 pulse/ft	CB1 1 pulse/ft
---------------------	--------------------------	--------------------------

- Single jet water meter
- Wet dial
- Roller reading
- Cold water up to 30 °C
- Max. connection 2" (50 mm)

HB Series	HB4 4 pulse/ft	HB1 1 pulse/ft
---------------------	--------------------------	--------------------------

- Single jet water meter
- Wet dial
- Roller reading
- Hot water up to 90 °C
- Max. connection 1 1/2" (40 mm)

CN Series	CN4 4 pulse/ft	CN1 1 pulse/ft
---------------------	--------------------------	--------------------------

- Single jet water meter
- Wet dial
- Roller reading
- Cold water up to 30 °C
- Max. connection 1 1/2" (40 mm)
- Mounting for solenoid dosing pump

RBF Series

- Single jet water meter
- Wet dial
- Roller reading
- Cold water up to 30 °C
- Max. connection 1 1/2" (40 mm)

DR Series	DR1 1 pulse/ft
---------------------	--------------------------

- Single jet water meter
- Dry dial
- Roller reading
- Cold water up to 30 °C
- Max. connection 2" (50 mm)

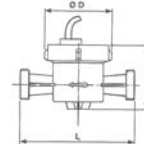
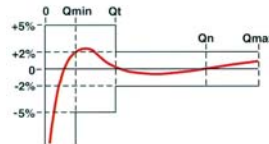

	Size	DN Inch	13	20	25	30	40	50
			1/2	3/4	1	1 1/4	1 1/2	2
hydraulic data	Max flow (short period)	Qmax m³/ft	3	5	7	10	20	30
	Nominal flow	Qn m³/ft	1.5	2.5	3.5	5	10	15
	Min flow (accuracy ±5%)	Qmin m³/ft	30	500	70	100	200	450
	Transition flow (accuracy ±2%)	Qt m³/ft	120	200	280	400	800	3000
	Maximum reading	m³	10000	10000	10000	10000	10000	10000
dimension data	Length without adapters	L mm	110	130	160	160	200	300
	Length with thread	mm	190	228	260	280	340	472
	Width	D1 mm	80	80	110	100	110	152
	Height	H mm	90	90	120	120	130	200

Flanged Water Meters

Woltmann Series						
	WE 25	WE 50	WE 100	WE 250	WE 500	WE 1000
lt/pulse	25	50	100	250	500	1000
Connections DN (mm)	50	50	50	-	-	-
	65	65	65	-	-	-
	80	80	80	-	-	-
	100	100	-	-	-	-
	-	-	-	150	150	150



	Size	DN Inch	50	65	80	100	150
			2	2 1/2	3	4	6
hydraulic data	Max flow (short period)	Qmax m³/ft	30	50	80	120	300
	Portata con 0.1 bar di perdita carico	m³/ft	20	55	65	120	300
	Nominal flow	Qn m³/ft	15	25	40	60	150
	Min flow (accuracy ±5%)	Qmin m³/ft	1.2	3	3.2	4.8	12
	Transition flow (accuracy ±2%)	Qt m³/ft	4.5	7.5	12	18	45
dimension data	Maximum reading	m³	10000	10000	10000	10000	10000
	Length	L mm	200	200	200	250	300
	Width	D1 mm	165	185	200	220	285
	Height	H mm	247	258	265	272	302
	Flange holes	Ø mm	18	18	18	18	22
		N°	4	4	4	8	8
	D2 mm	125	145	160	180	240	

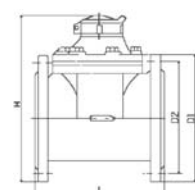
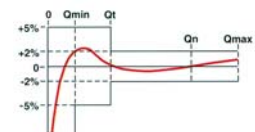

Accessories

Tanks in polyethylene

Our tanks are designed to assemble dosing systems with mixers and motor driven pumps or solenoid dosing pumps. All are made from food-safe polyethylene, resistant to almost all chemicals normally encountered.

Models and Technical Features			
Tank Code	Capacity (Lt)	Height (cm)	Diameter (cm)
SER 50	50	45,5	40
SER 100	100	64	46
SER 250	250	87	59,5
SER 300	300	95	67
SER 500	500	118,5	76
SER 1000	1000	122	108,5



Reinforcement

Tank reinforcement made of PVC (20 mm thick) to be used to install mixers and motor driven pumps or solenoid dosing pumps on tanks SER series.

Models	
Code	Tank
SML 100	SER 100
SML 250	SER 250
SML 300	SER 300
SML 500	SER 500
SML 1000	SER 1000



Uncovered Tanks in Polyethylene

Designed to contain our tanks SER series

Models and Technical Features				
Code	Tank	Capacity (Lt)	Height (cm)	Diameter (cm)
T150	SER 100	150	75,5	51
T300	SER 250	300	87,5	67
T400	SER 300	400	99	72
T800	SER 500	800	120	90
T1500	SER 1000	1500	134	122



Mixers

Electric mixers three-phase (single-phase on request) and flange attachment. For tanks SER series.

Technical Features					
Body	Shaft length (mm)	Propeller diameter (mm)		Motor (kW)	SER Model
		Slow (70 rpm)	Fast (1400 rpm)		
PVC AISI 316	600	150	90	0,13	100
	800				250
	900	300			
	1100				500/1000

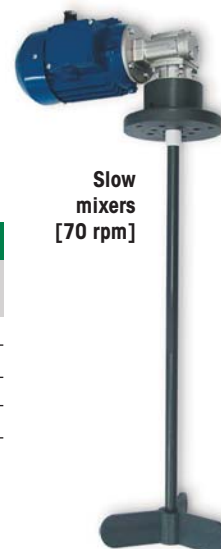

Suction Devices

A suction filter is provided to protect pump valves from debris or particles that could obstruct the pump valve. Suction devices can also be supplied with integral level controls. These allow the use of alarms, and protect against the system running dry.

- Easy to install
- Standard FPM seals (EPDM upon request)
- Made of PCV with clear PVC suction tubing
- All suction devices are provided with a foot filter
- All suction devices are provided with a non return valve

Technical Features			
Dimensions (mm) Length x Ø	Tube 4x6	Tube 8x12	Tank suitability
450 x 22	•		SER 50
450 x 34		•	
650 x 22	•		SER 100
650 x 34		•	
900 x 22	•		SER 250
900 x 34		•	
1050 x 22	•		SER 300
1050 x 34		•	
1250 x 22	•		SER 500-1000
1250 x 34		•	



Pump head with automatic degassing valve

It allows to resume the right dosing without any intervention from the user, in case you meter some products generating gases.

PVC body, FPM seals and Ceramic balls for the best chemical compatibility. **Bear in mind:** to be exclusively used combined with 603 and 800 series pumps

Technical Features

Max temperature of liquid product 40° C
Max flow rate reduction 20%



HY Series adjustable valves

Material	PVC
Max flow rate	50 l/h
Max pressure	10 bar
Connections	1/2" g.m., tube 8x12, tube 4x6
Diaphragm	FPM (standard) or EPDM (upon request)
Max temperature of liquid	35 °C

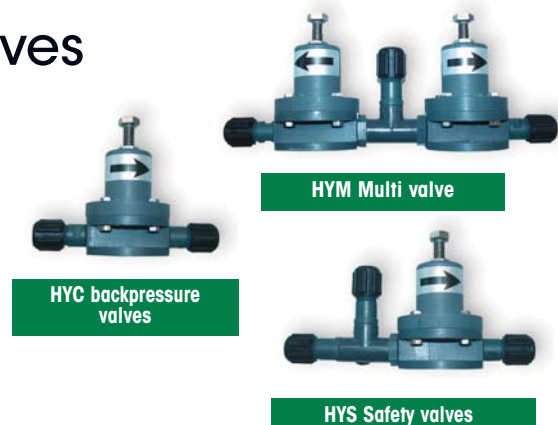

Accessories

Injection valves

Material	PVC
Max flow rate	50 l/h
Connections IN	1/2" g.m., tube 8x12, tube 4x6
Connections OUT	1/2" g.m.

Max working pressure	10 bar
Seals	FPM (standard) or EPDM (upon request)
Max temperature of liquid	35 °C



Multifunction valve

Multifunction valve acts as: a back pressure valve, an anti-siphoning valve, a safety valve, a priming valve, a delivery drain valve (for maintenance) . Multifunction valve is fitted directly on the delivery valve on the dosing pump.

Materials		Ø Connections
Valve body	Diaphragm	IN/OUT [mm]
PVC	PTFE	4/6(*)
PVDF		

Technical Features

Safety valve with pressure selection	6(*) - 12 bar
Back pressure valve with pressure	1.5 bar
Max temperature of liquid	40°C

(*) 6 bar type, supplied with 8/12 tube connections



Fixed / Adjustable backpressure valves

The accuracy of the solenoid pumps can be affected by the variation of delivery pressure, especially between 0 and 1 bar. Using the backpressure valve you can guarantee a constant dosing and avoid siphoning cases when metering in the tank. Moreover, dosing with a backpressure avoids to create siphoning phenomena of the pump.

Materiali		Ø Connessioni	
Corpo Valvola	Membrana/Tenute	IN	OUT
PVDF	FPM	4/6 mm	3/8" G
	EPDM		1/2" G

Technical Features

Fixed Version Backpressure 1,5 bar	Adjustable Version Backpressure 0,5 - 5 bar
---------------------------------------	--

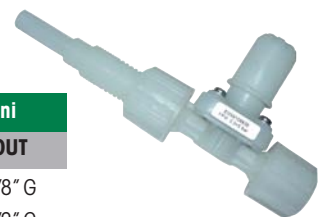

Flow Sensor

In order to assess the actual dosing phase, the flow sensor can be used to detect the pump's pulsations during the delivery phase: the sensor can also be used to determine the actual dosing flow rate. This flow sensor is fitted directly on the delivery valve on the dosing pump.

Materials	
Body	Seals
PVC	PTFE
PVDF	

Technical Features

Max pressure 10 bar
Max temperature of liquid 40° C



Priming-aid

Priming problems may occur on dosing pumps with a low flow rate, and also in case of excessive suction heights in relation to the pump's capacity. This accessory is able to resolve these problems. Where possible it is fitted at the same height as the pump's intake valve and a short distance from it.

Materials		Ø Connessioni	Model
Body	Seals	IN/OUT [mm]	
PVC	FPM	4/6 - 8/12	300 ml

Technical Features

Max temperature of liquid 40° C



